

8V WMM E 06

PO PST140

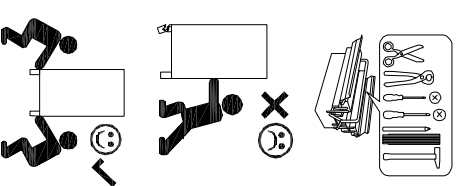

- (D)** Montageanleitung
- (FR)** Notice de montage
- (NL)** Handleiding voor de montage
- (CZ)** Montážní návod
- (HU)** Szerelési útmutató
- (TR)** Montaj talimatı

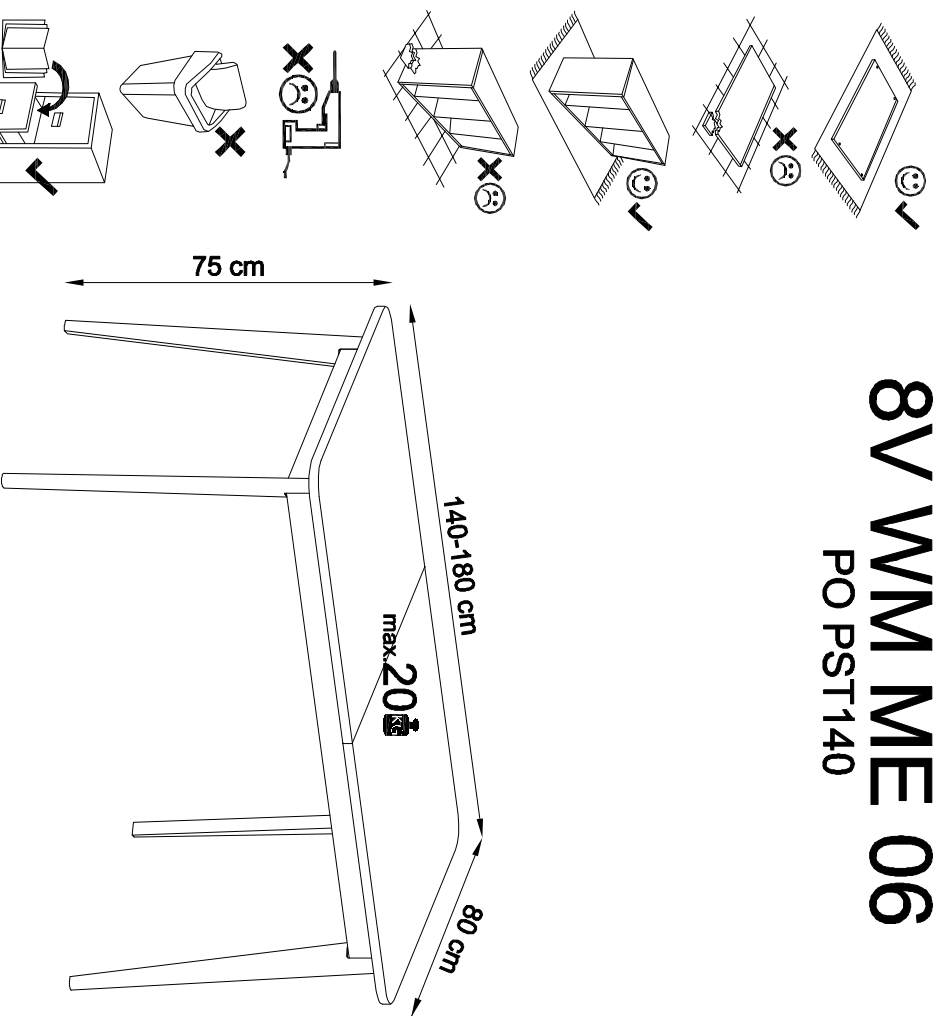
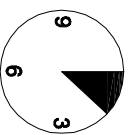
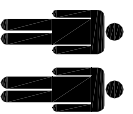

50 min.

- (GB)** Assembly Instructions
- (IT)** Istruzioni di montaggio
- (PL)** Instrukcja montażu
- (SK)** Návod na montáž
- (RO)** Instrucțiuni de montaj
- (RU)** Инструкции по монтажу

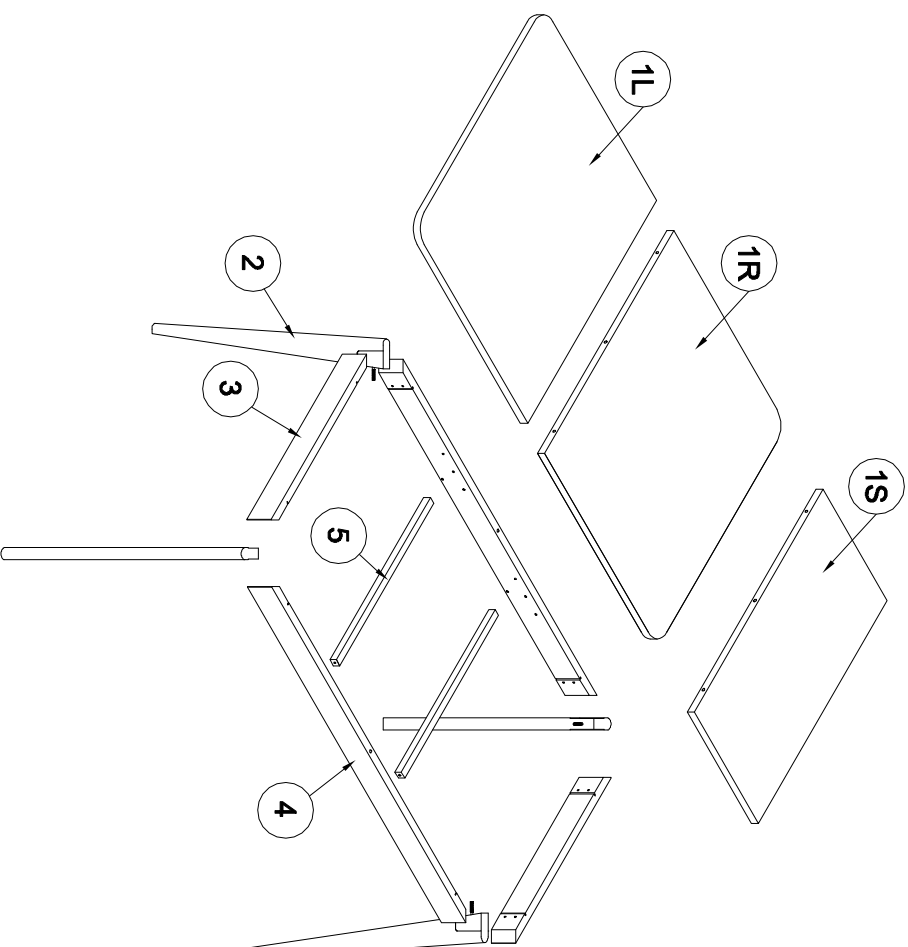

	1/2			
1L/1R	70	x 80	x 2.2	cm
1S	40	x 80	x 2.2	cm

	2/2			
2	74	x 7.6	x 3	cm
3	59.5	x 7.5	x 1.8	cm
4	120	x 7.5	x 1.8	cm
5	60	x 1.8	x 1.8	cm

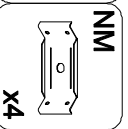
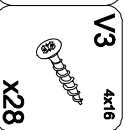
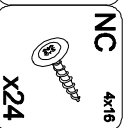
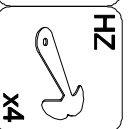
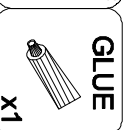
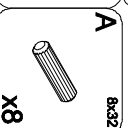
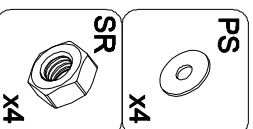



Увага • Urozorníni • Achtung • Attention • Caution • Figyelem
Attenzione • Orgelet • Внимание • Ateñje • Urozornenie • Dikkat

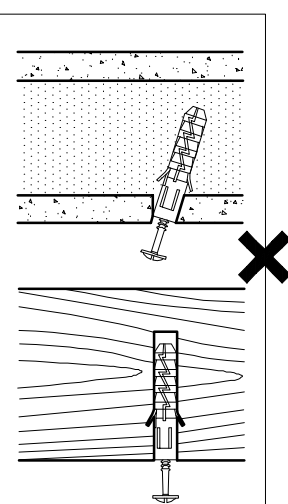
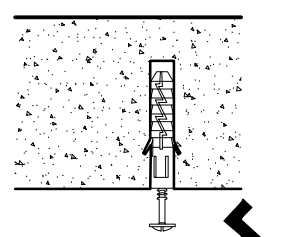
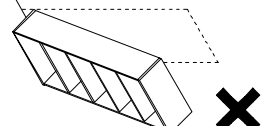
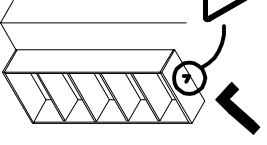
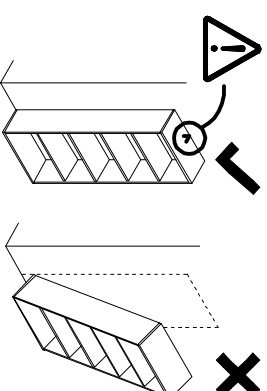
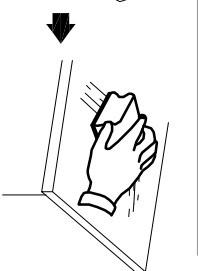
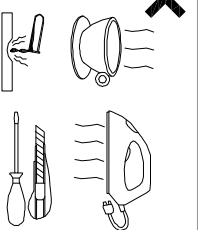
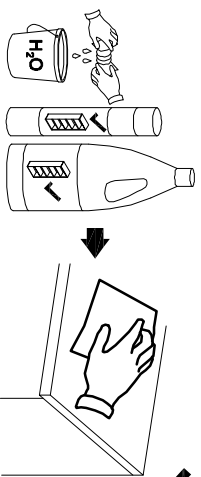
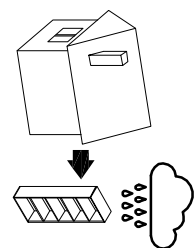
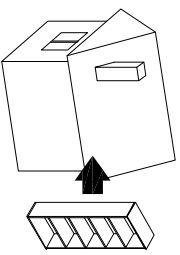

PL	Czyszczenie należy wykonać wyłącznie za pomocą ściereczki lub lekko nawilżonego ręcznika. Nie stosować środków czyszczących do szorowania.
CZ	Čistění je nutné vykonávat výhradně pomocí utěrky nebo lehce navlhčeného ručníku. Nepoužívejte čisticí prostředky obsahující abrazivní částice.
DE	Bitte nur mit einem Staubtuch oder leicht feuchtem Lappen reinigen. Keine scheuernden Putzmittel verwenden.
GB	Please only clean with a duster or damp cloth. Do not use any abrasive cleaners.
FR	Le nettoyage se fait uniquement à l'aide d'un torchon ou d'une serviette légèrement mouillée.
NL	Reinig alleen met een stofdoek of een lichtjes vochtige doek. Gebruik geen schurende poetsmiddelen.
IT	Pulire esclusivamente con un panno o un asciugamano umido.
HU	A tisztítás kizárólag törölközővel vagy enyhén nedvesített törölközővel véggezhető. Súroló hatású tisztítószereket nem szabad használni.
RU	Чистайте от пыли тряпкой или слегка влажной ветошью. Не допускаются применение чистящих средств, не пред-назначенных для ухода за мебелью.
RO	Curăţarea trebuie efectuată numai cu o cârpă sau cu un prosop umed.
SK	Čistenie je nutné vykonať výhradne pomocou utierky alebo ľahko zvlhnutým ručníkom. Nepoužívajte čistiace prostriedky obsahujúci abrazívni častice.
TR	Lütfen sadece bir toz bezilye veya hafif nemli yumuşak bir bezle siliniz. Aşındırıcı temizlik malzemeleri kullanmayın.

PL	Mocowanie do ściany jest konieczne! Nie zabezpieczanie przed przewróceniem - koniecznie zamontować! Do niektórych rodzajów ścian konieczne zastosować specjalne kołki mocujące.
CZ	Montáž na stěnu slouží jako ochrana proti převrnutí - bezpodmínečně umístěte! U některých typů stěn může být zapotřebí speciální hmoždinky!
DE	Wandbefestigung dient als Kippschutz - unbedingt anbringen! Bei einigen Wandtypen kann ein Spezialdübel erforderlich sein!
GB	The wall fastening serves to prevent tipping - be absolutely sure to mount it! For certain wall types, a special wall plug may be necessary!
FR	La fixation murale sert de protection contre le basculement - à installer impérativement! Pour certains types de murs il faut des chevilles spéciales!
NL	Bevestiging aan de muur dient als kantelbescherming - zeker en vast bevestigen! Bij enkele muurtypen is een speciale plug misschien vereist!
IT	Il fissaggio alla parete serve da protezione anti-ribaltamento-attaccarla assolutamente! Per alcune strutture di parete può essere necessario un tassello speciale!
HU	A terméket a falhoz kell rögzíteni, külsőben az felborulhat! Egyes falípusoknál speciális típusú köll kell használni!
RU	Обязательно установите крепление на стене во избежание опрокидывания! Для некоторых типов стен может потребо- ваться специальный дюбель!
RO	Sistemul de fixare la perete serve ca protecţie la răsturnare - de montat obligatoriu! Pentru unele tipuri de pereţi este posibil să fie necesar un dibel special!
SK	Upevanie na stenu slúži ako ochrana proti prevráteniu - bezpodmienečne použiť! Pre niektoré druhny stien môže byť potrebná špeciálna hmoždinka!
TR	Duvardaki sabitleme, devrilmeye karşı bir emniyet tedbiridir ve mutlaka monte edilmelidir! Bazı duvar tiplerinde bunun için özel bir dübel gereklidir!

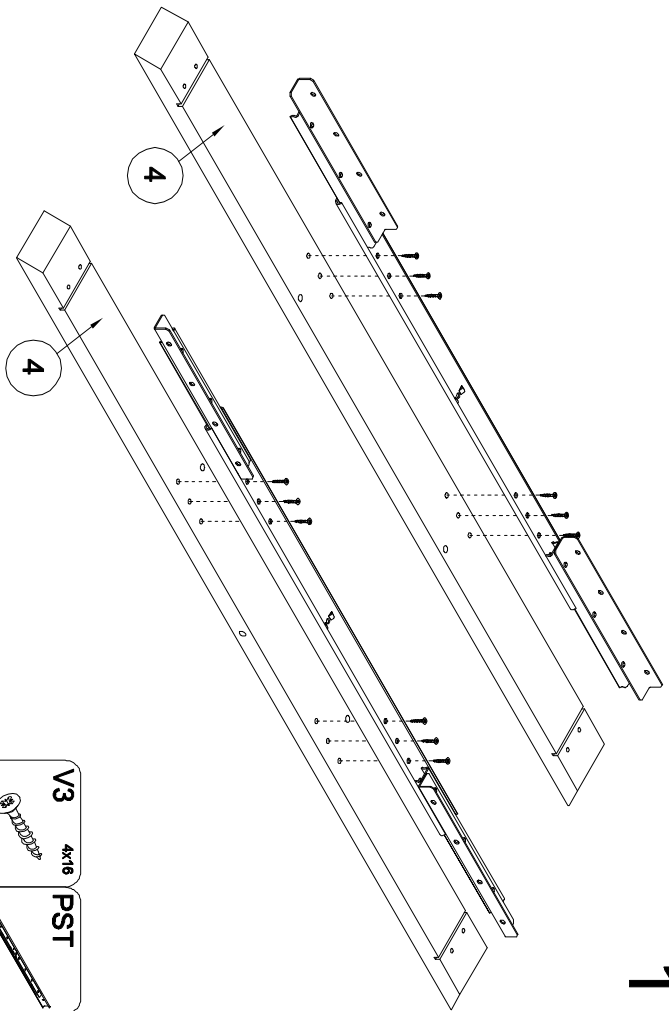

- V3 4x16 x12
- PST x2

1

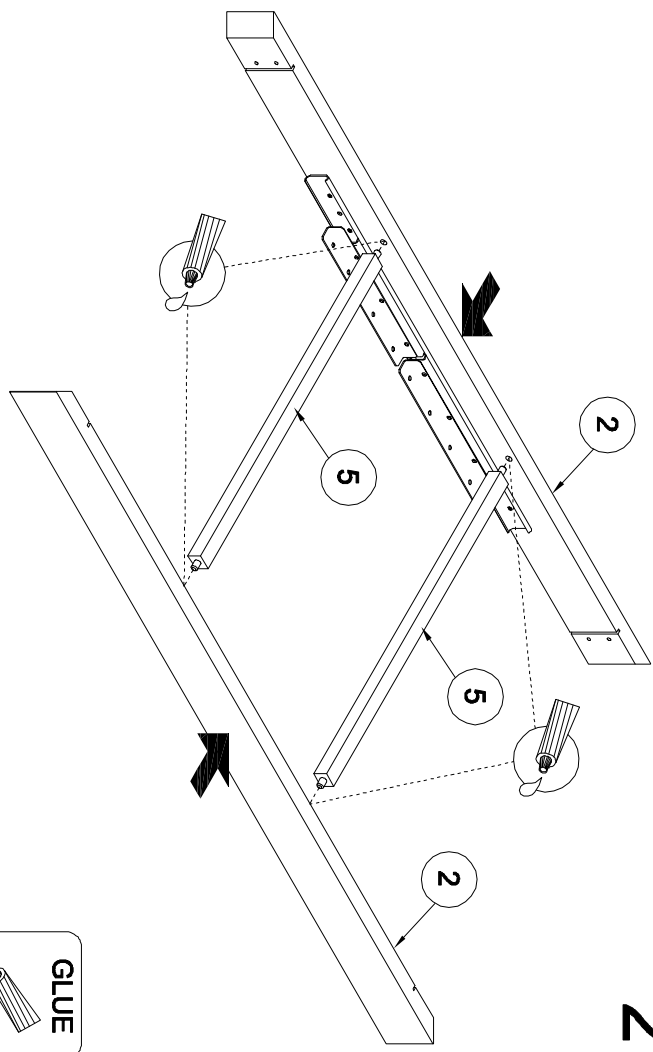

- GLUE x1

2

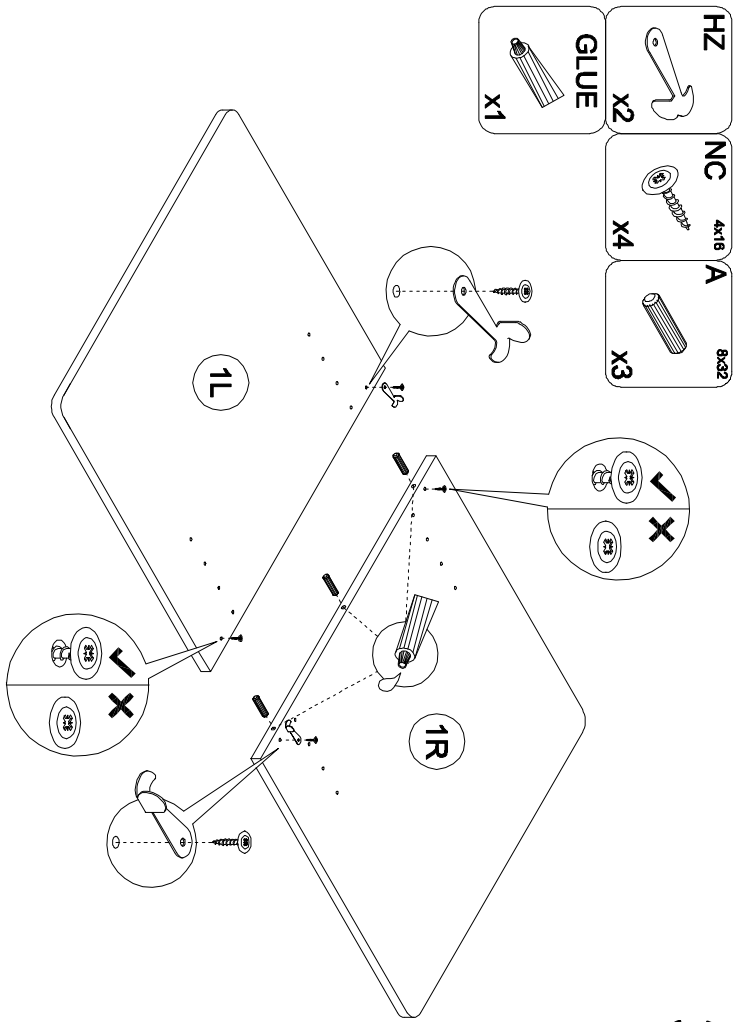

- HZ x2
- GLUE x1
- NC 4x16 x4
- A 8x32 x3



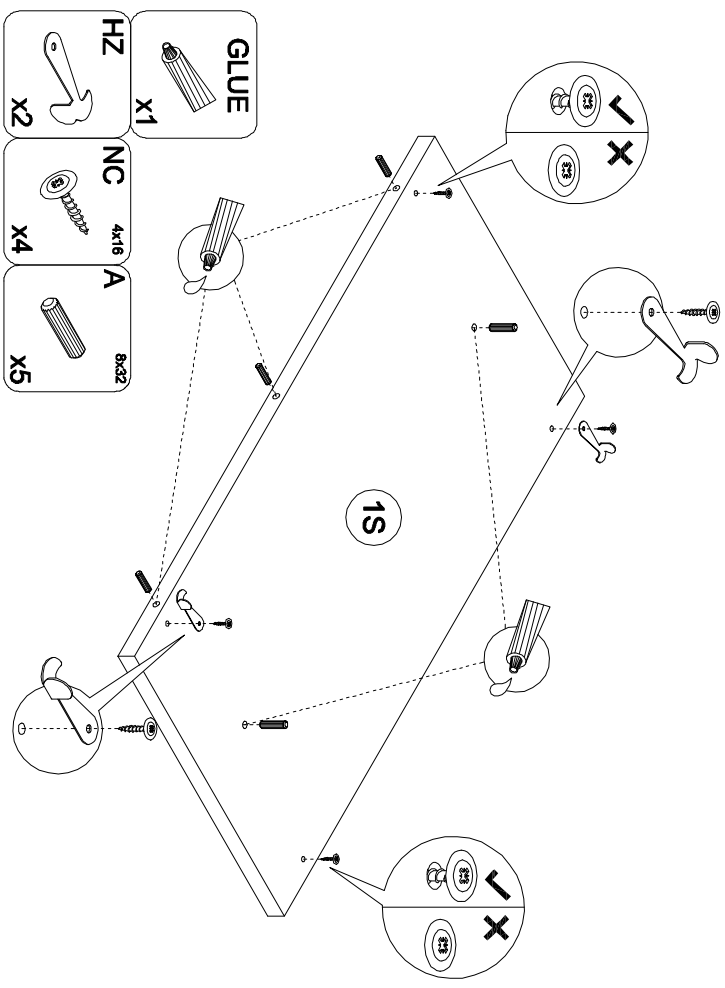

3

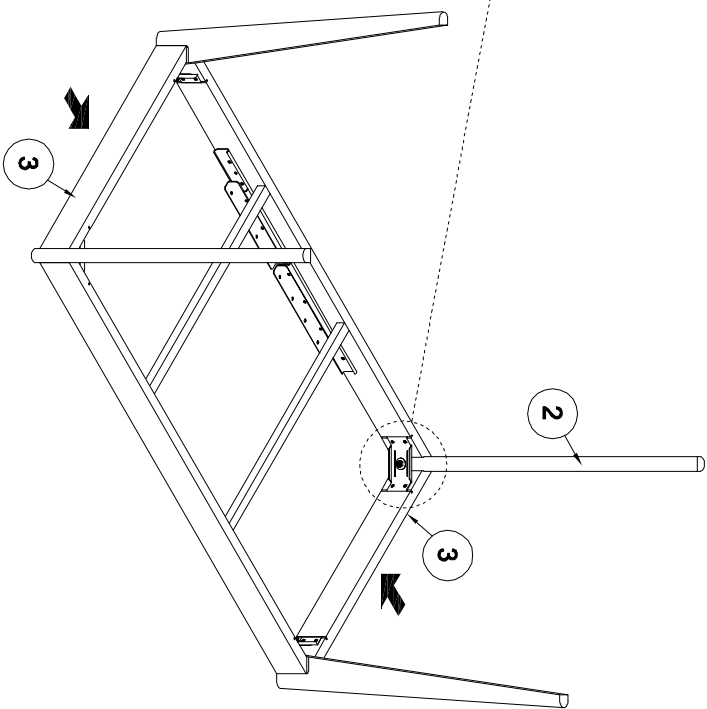
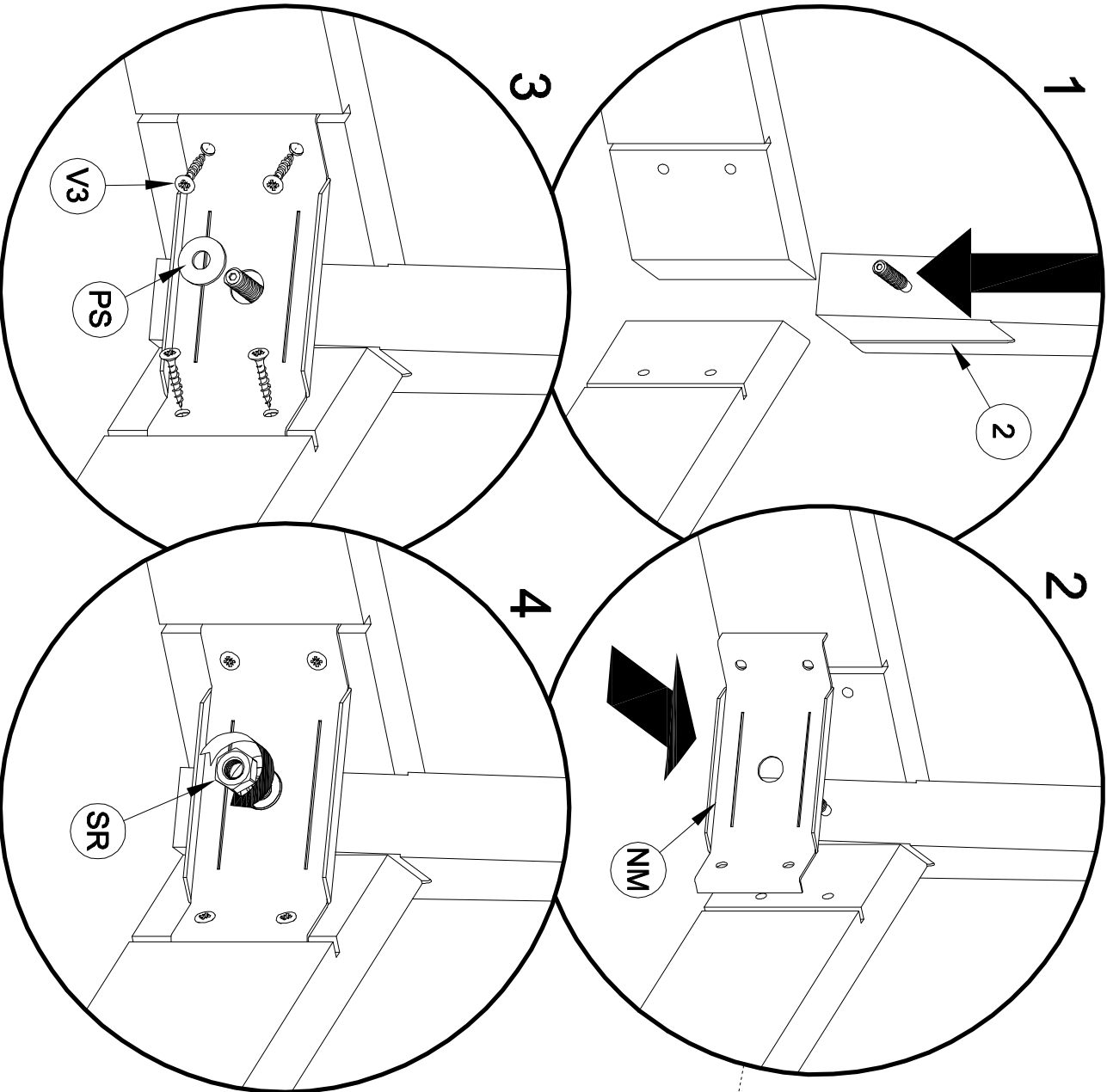

- GLUE x1
- HZ x2
- NC 4x16 x4
- A 8x32 x5

4



	NM	x4
	V3	x4
	SR	x4
	PS	x4
		x16

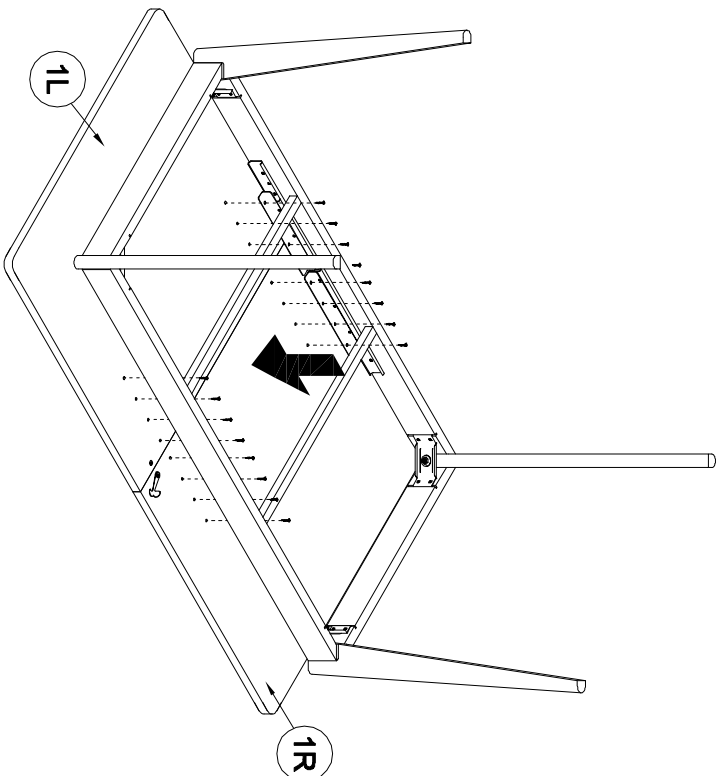

6

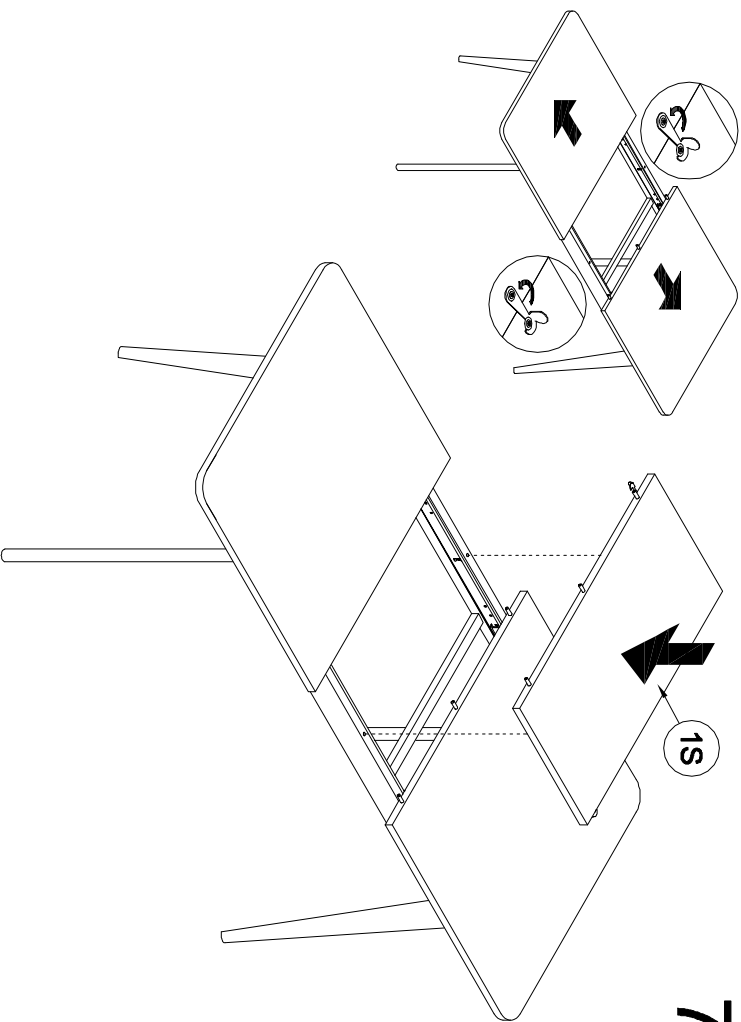

7

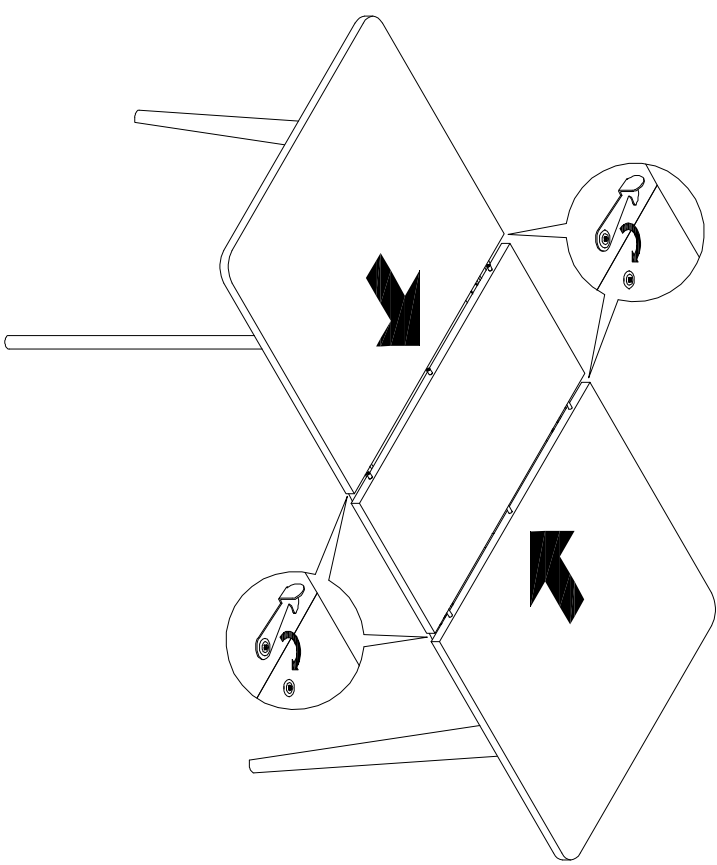

8

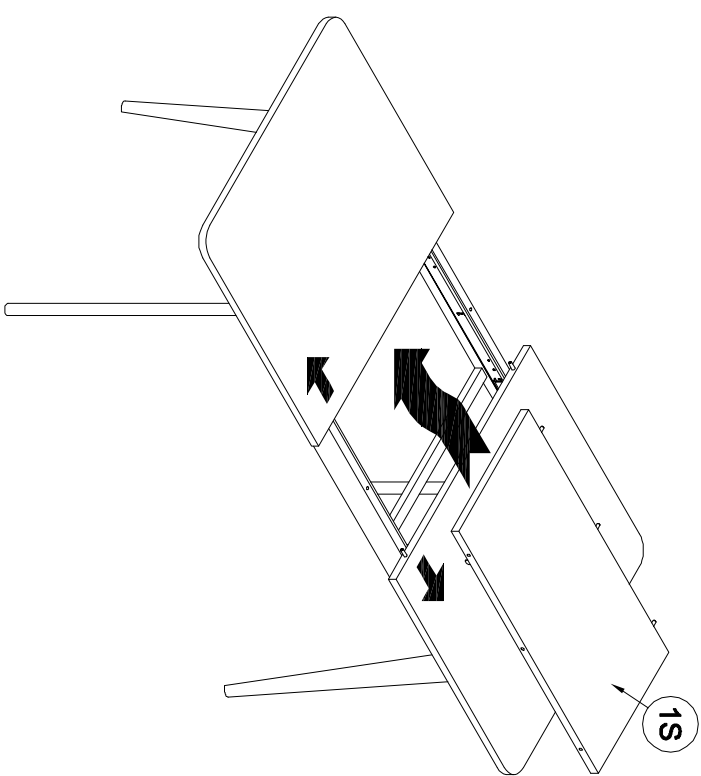

9